



FCBARCELONA
més que un club

events@fcbarcelona.cat

+ 34 93 496 37 94 • + 34 93 496 36 35 • + 34 93 496 36 00

www.fcbarcelona.cat

Official Sponsors of FC Barcelona:



FCBARCELONA
més que un club

Meetings & Events
Celebrate them in the Camp Nou



Index

- The city and the club 5
- Meetings & Events 9
- Lounges & Rooms 11
- Sports facilities 29
- M & E Services 38
- Contact details 47
- FCB Hospitality services 48
- Location 51



An unforgettable city



Barcelona is a modern and cosmopolitan city, but also one that has inherited many centuries of history. The Mediterranean and its openness to Europe define the character of the capital of Catalonia.

It enjoys a privileged location, on the shores of the sea, surrounded by mountains and is very well communicated by land, sea and air with other international capitals.

It can boast a valuable architectural and monumental heritage, with the high points of its splendour being the Gothic and Modernist periods, and the city is home to no fewer than nine buildings that have been declared World Heritage Sites.

Since the Olympic Games in 1992, the city has possessed a wide range of first class hotels offering innumerable comforts in accordance with European standards, and which are renowned for their excellent quality services and exceptional customer care.

Barcelona has developed into one of Europe's tourist hotspots, and especially for trade fairs, congresses, meetings and different events. Its perfect climate, the high quality of its hotel infrastructure and the increase in international fairs are factors that are held in very high regard indeed by visitors.



More than a club



FC Barcelona has more than 100 years of history and now has 160,000 members, making it one of the most respected and admired clubs in the world. It is known the world over for its attack-minded attitude to football as entertainment, while for its members and fans, FC Barcelona is considered 'more than a club'. Historically, this slogan has represented the club's sentiments and reflects the club's social commitments around the world.

Thanks to being a multi-sport organisation, the club now possesses some fabulous facilities, the Camp Nou stadium being the most emblematic of all.

FC Barcelona's Camp Nou stadium is one of the icons of the city of Barcelona and one of the most legendary venues in world football. Almost 100,000 spectators can enjoy magnificent nights in the biggest and most spectacular stadium in Europe, which was granted five-star status by UEFA.



The ideal setting for your event



FC Barcelona's Meetings & Events team can provide you with an integral service for the organisation of personalised and creative events.

Our multifunctional professionals are specialists in marketing, communication and PR and with so much experience of running events will be able to understand all your needs and have the capacity to adapt everything to the high standards required by your company.

All of this in the incomparably magnificent setting of such an emblematic club as FC Barcelona.

The club can provide you with a wide range of rooms and areas that offer a unique ambience and plenty of symbolism. You can reserve rooms and areas that come with their own production team, who will be able to offer you all the services your event requires, with as much personalisation as necessary.

Corporate events

- Meetings
- Business lunches and suppers
- Cocktails and receptions
- Product presentations
- Showrooms
- Incentives and training

Sports events

- Company games and tournaments
- Sports clinics
- Team training camps

Camp Nou Rooms

		DIMENSIONS (m ²)	MEASURES	BANQUET	COCKTAIL	SCHOOL	THEATRE	IMPERIAL	"U"
①	Paris 2006 Lounge	360	20x18x3	200	300	250	400	170	175
②	Roma 2009 Lounge	520	50x10x3	240	360	100	150	100	
③	Grandstand Hall	1,100		750	1,000				
④	Presidential Anteroom	182	14x13x2	80	125				
⑤	Camp Nou Terrace	300	24x12		200				
⑥	Honor Anteroom [Presidential Area]	217	31x7x3	110	160				
⑦	Foundation Lounge [Presidential Area]	180	18x10x3	70	100	50	70	50	45
⑧	Museum Space - 1st floor	800		400	500				
	Museum Space - 2nd floor	600		150	200				
⑨	Lateral Box Anteroom	350	27x13x2	160	260	60	80	170	40
⑩	Mediapro Lounge	375		175	260	40	50	175	
	1st Tier Auditorium								
⑪	Trophy Room	80	10x8x2	30	30		20		15
⑫	Honor Anteroom + Foundation Lounge + Presidential Anteroom	500		230	350				
	• Palau Blaugrana Arena	800	40x20	370	560	400	800		
	• Palau Blaugrana Arena VIP Room	126	7x18x5	70	100				

Each room includes: **P** Free parking and stewardess service

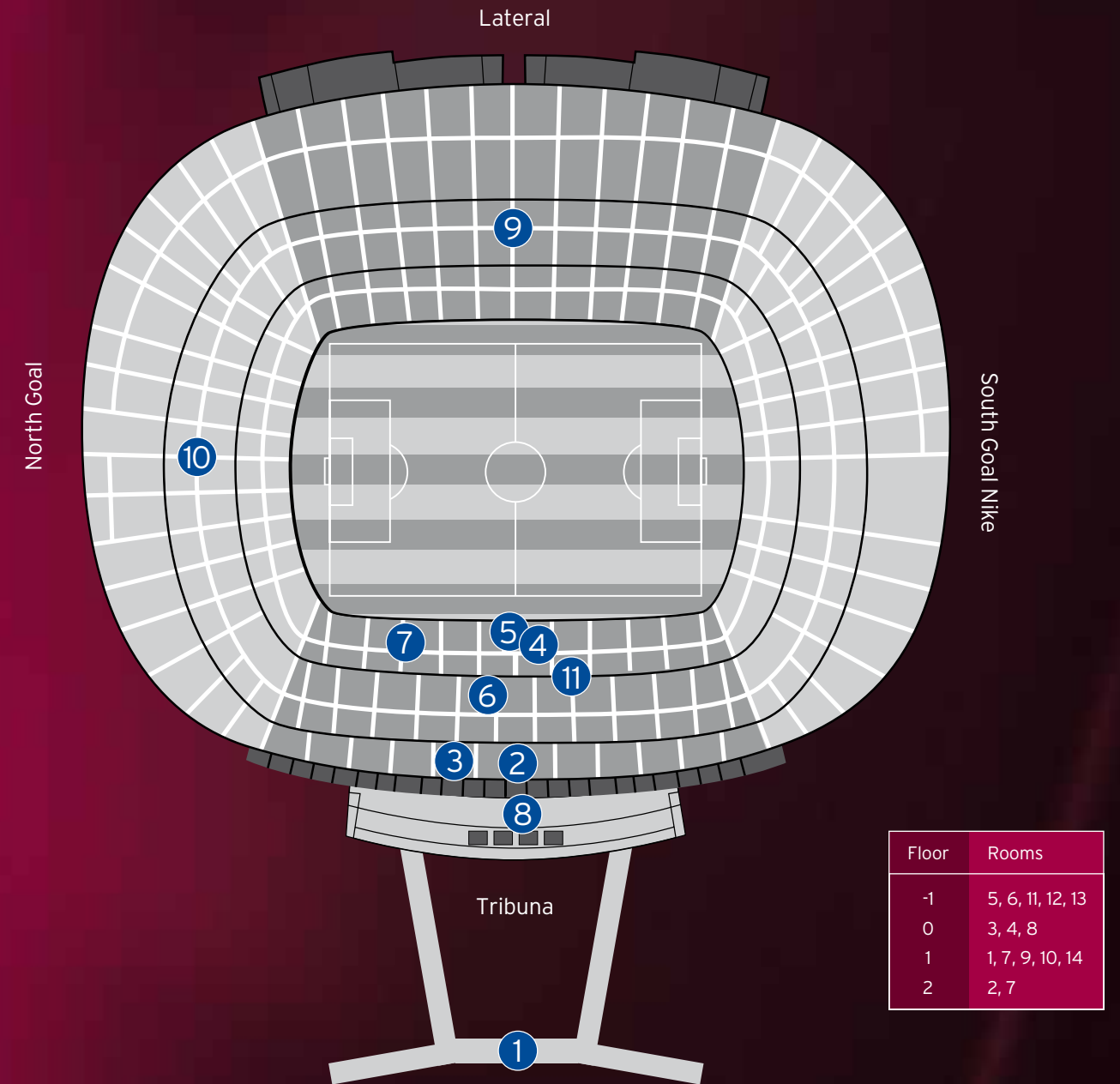

Floor	Rooms
-1	5, 6, 11, 12, 13
0	3, 4, 8
1	1, 7, 9, 10, 14
2	2, 7



Paris 2006 Lounge

This square lounge with an immense glass window offering plenty of natural light and views of the main Camp Now façade is equipped with two large screens and decorated with a mural of the team that won the Champions League in Paris in 2006. It is one of the stadium's most versatile rooms and is famous for being the venue for the presentations to the media of several new signings.

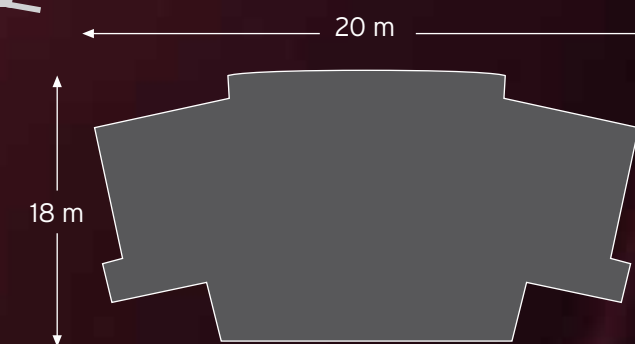
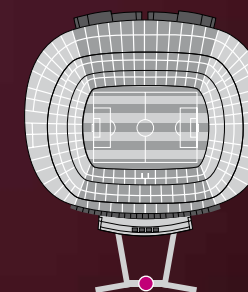

Dimensions	Banquet	Cocktail	School	Theatre	Imperial	"U"
360m ²	200 pax	300 pax	250 pax	400 pax	170 pax	175 pax



Roma 2009 Lounge

⦿ This recently constructed and decorated venue is sophisticated in style and offers splendid views of the area around the stadium thanks to its large glass window and position above the main grandstand.

It can be divided into three large spaces thanks to a modern system of panels. It has two bars and a kitchen and links internally to ten private boxes that can be used for fractionated meetings with direct access to the stadium.

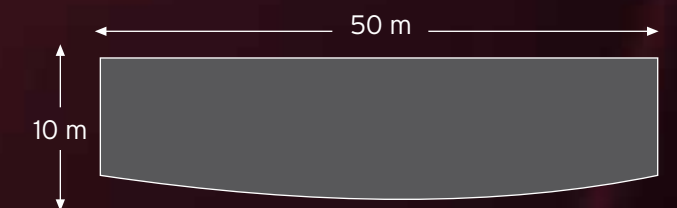
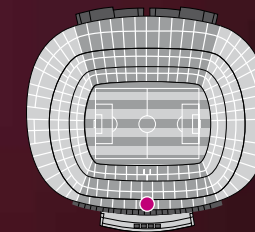

Dimensions	Banquet	Cocktail	School	Theatre	Imperial	"U"
520m ²	240 pax	360 pax	100 pax	150 pax	100 pax	-



Grandstand Hall

A large capacity area for events involving up to 1,000 people. Located by the main stadium entrance, it is unbeatably accessible and connects to the interior of the Camp Nou through four exits. The events held here can be personalised to achieve a high level of sophistication and spectacle, incorporating activities both on the outer staircase and in the main grandstand or on the pitch.

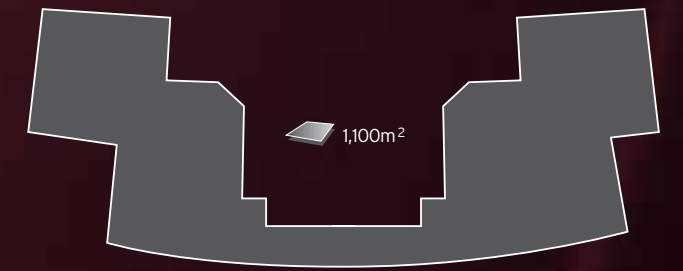
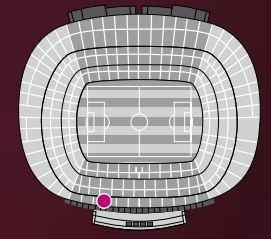

Dimensions	Banquet	Cocktail	School	Theatre	Imperial	"U"
1,100m ²	750 pax	1,000 pax	-	-	-	-

Presidential Anteroom



The most honourable place of all in the Camp Nou, where numerous personages from all walks of life meet on match days.

It includes a direct connection to the most privileged zone in the grandstand, and which offers the finest view of the stadium.

The room contains several works of art, is covered in marble and provides a bar service.

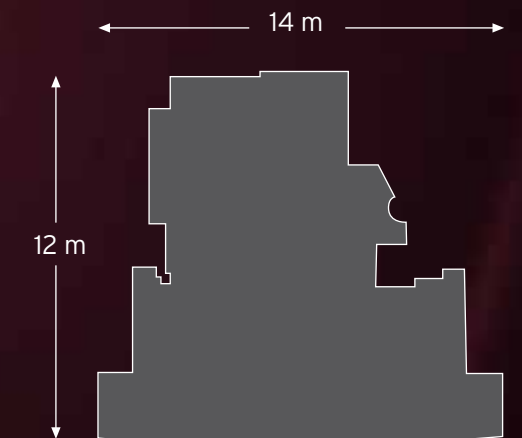
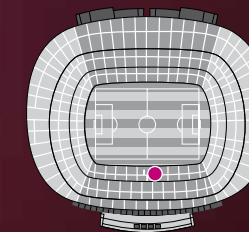

Dimensions	Banquet	Cocktail	School	Theatre	Imperial	"U"
182m ²	80 pax	125 pax	-	-	-	-



Camp Nou Terrace

Spectacular terrace inside the Camp Nou. The events held in this space enjoy the utmost privacy and a unique view of the pitch and the empty terraces of the Camp Nou. It is particularly appropriate for welcome drinks, cocktails, presentations and large scale shows. Situated in the 1st tier of the grandstand, it can be used to enjoy an open air event, under protection from the sun and rain thanks to the architectonic grandstand roof.

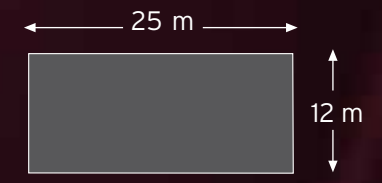
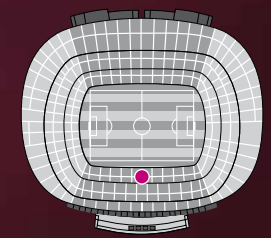

Dimensions	Banquet	Cocktail	School	Theatre	Imperial	"U"
300m ²	-	200 pax	-	-	-	-



Presidential Area

Honor Anteroom

Located just beneath the presidential zone, the modern décor using dark woods and noble materials beneath a sloped skylight give this room a modern and distinguished appearance.

It is equipped with furniture and several plasma screens. It is noted for its versatility and the possibility of being used in combination with adjacent spaces.

Dimensions	Banquet	Cocktail	School	Theatre	Imperial	"U"
217m ²	110 pax	160 pax	-	-	-	-

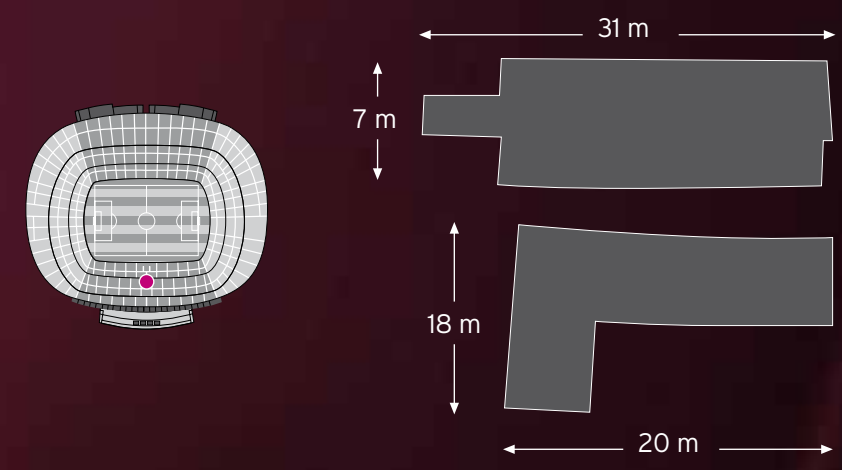

Foundation Lounge

Dimensions	Banquet	Cocktail	School	Theatre	Imperial	"U"
180m ²	70 pax	100 pax	50 pax	70 pax	50 pax	45 pax

Designed as a continuation of the box anteroom, this room offers partial views over the pitch. It is the ideal space for small-format meetings and cocktail receptions. It is perfectly located underneath the presidential box, with partition walls and elegant dark coloured wooden décor.



Museum Space

The most visited sports museum in the world and the most frequented museum in the city is located in the heart of the Grandstand zone.

Its two floors are used to host events in an unrivalled setting. The space is surrounded by 110 years of club history including a new multimedia zone where some of the most emotional moments in club history can be revisited in a very special way.

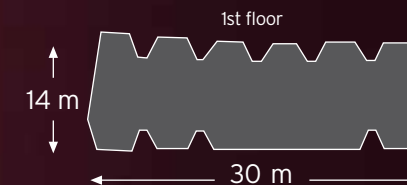
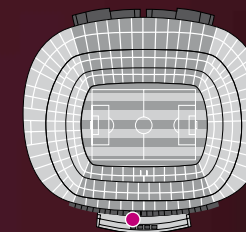

1st floor	Dimensions	Banquet	Cocktail	School	Theatre	Imperial	"U"
	800m ²	400 pax	500 pax	-	-	-	-
2nd floor	Dimensions	Banquet	Cocktail	School	Theatre	Imperial	"U"
	600m ²	150 pax	200 pax	-	-	-	-

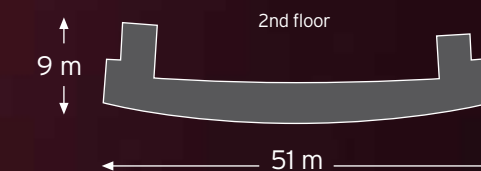

Lateral Box Anteroom

Located in the lateral area, this room offers partial views of the terraces and is decorated in colourful wooden tones and with different works of art depicting sporting themes. Its main characteristics are functionality and polyvalence.

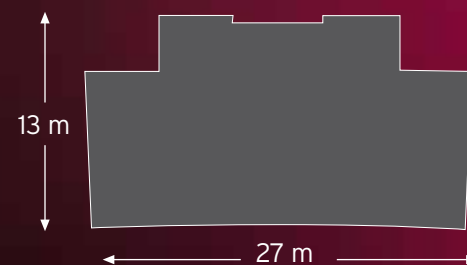
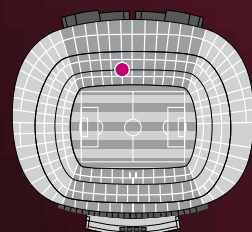

Dimensions	Banquet	Cocktail	School	Theatre	Imperial	"U"
350m ²	160 pax	260 pax	60 pax	80 pax	170 pax	40 pax





Mediapro Lounge

Located behind the North Goal, with views of La Masía and Tibidabo through its vast glass window.

It combines elegant wooden decoration with large format photographs of FC Barcelona players in action and several plasma screens dotted around the room.

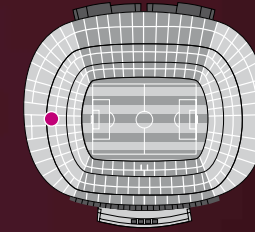

Dimensions	Banquet	Cocktail	School	Theatre	Imperial	"U"
375m ²	175 pax	260 pax	40 pax	50 pax	175 pax	-



1st. Tier Auditorium

The grandstand seats provide an original and improvised auditorium to surprise your visitors with a presentation or welcome speech.

The montage can be personalised by installing a platform or stage on the terraces or the actual pitch along with whatever audiovisual equipment is required, along with the possibility of using the stadium's video scoreboards and large-format projections onto the pitch.

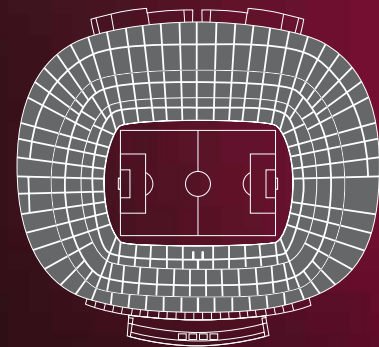

Sports facilities

		DIMENSIONS (m ²)	MEASURES
①	Camp Nou (football field)	7,140	105x68
	Camp Nou (football field tartan)	8,200	
②	Miniestadi (football field)	6,695	103x65
③	Training pitch nr. 3	6,460	95x68
④	Palau Blaugrana Arena	800	40x20
⑤	Ice Rink		
⑥	Sports Complex Joan Gamper	136,839	
	Grass Pitches	6,825	105x65
	Artificial Grass Pitches	6,825	105x65
	Multisport Pavilion	1,590	53x30x10

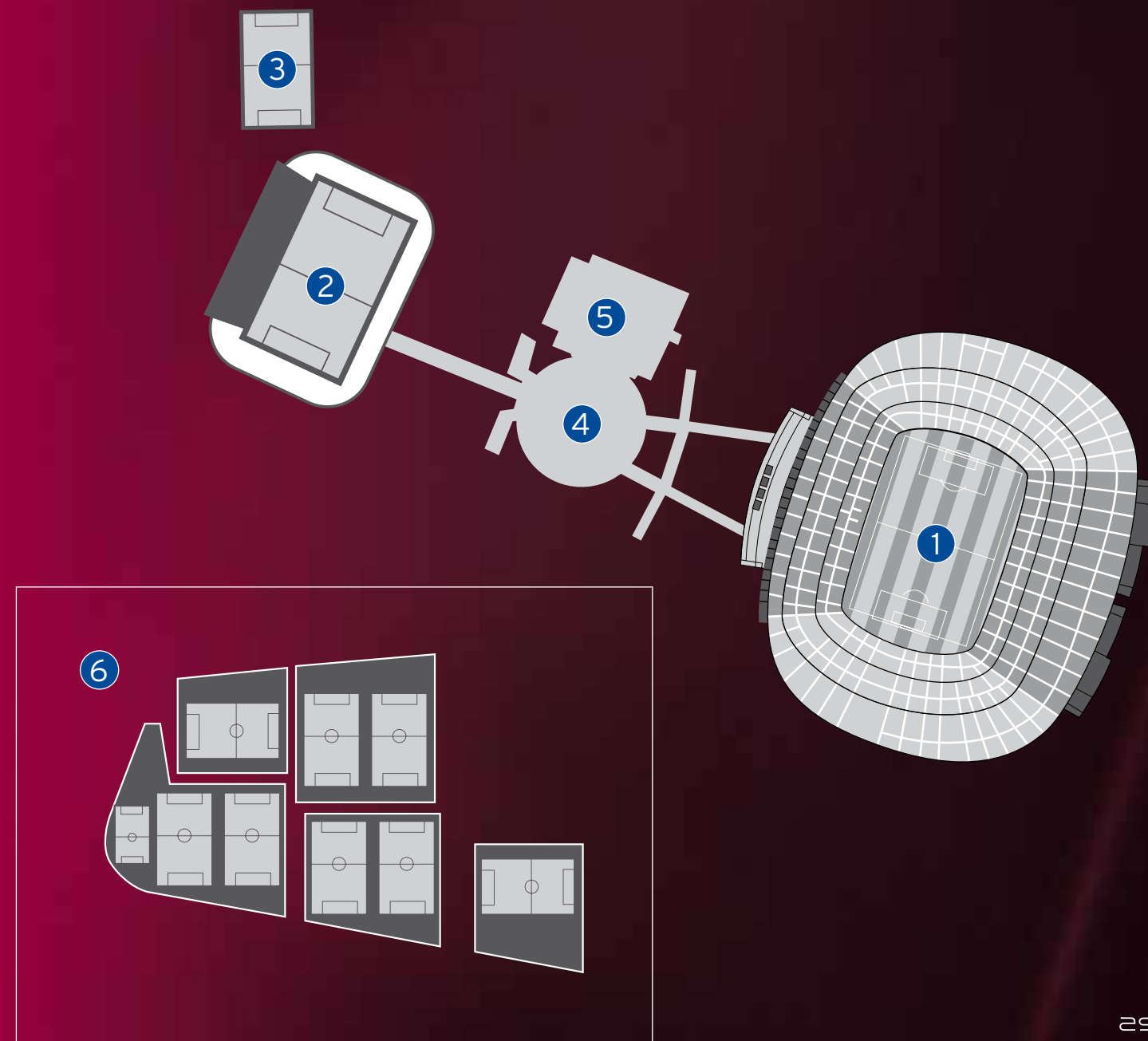

Camp Nou



The biggest football stadium in Europe, with a capacity for more than 98,000 spectators, is UEFA catalogued as a 5 star stadium due to its high standards of safety and comfort.

Inaugurated in 1957 and remodelled on several occasions, it is located in the central district of Les Corts, just 15 minutes from the airport and the city centre. It has excellent public transport connections and plenty of parking space.

The grounds are also home to the FC Barcelona museum, the indoor Palau Blaugrana Arena, the Ice Rink, the FCBotiga Megastore and the Miniestadi, among other facilities.

It is ideal for large concerts, film recordings, product presentations, friendly matches and other activities.

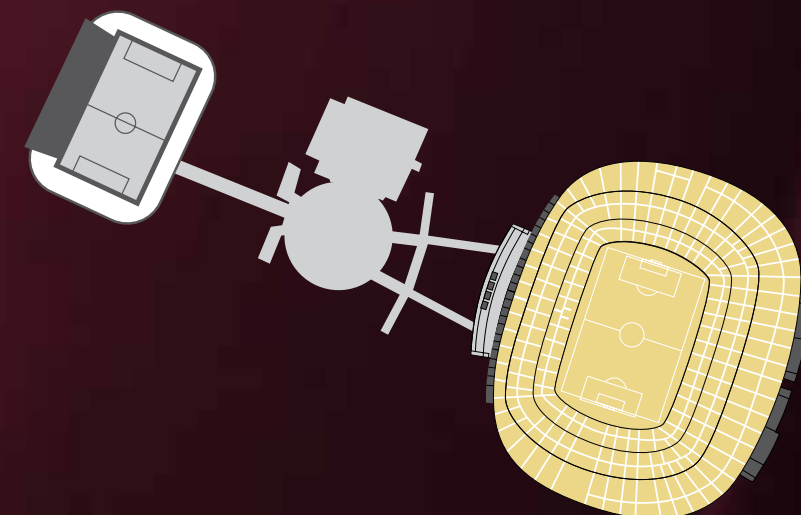

Miniestadi



Located alongside the Camp Nou and connected to the main grounds by an overhead passageway, this is where the club's reserve team plays its games.

It has the capacity for over 15,000 spectators and is ideal for sports events, film recordings, projections, meetings and other activities.

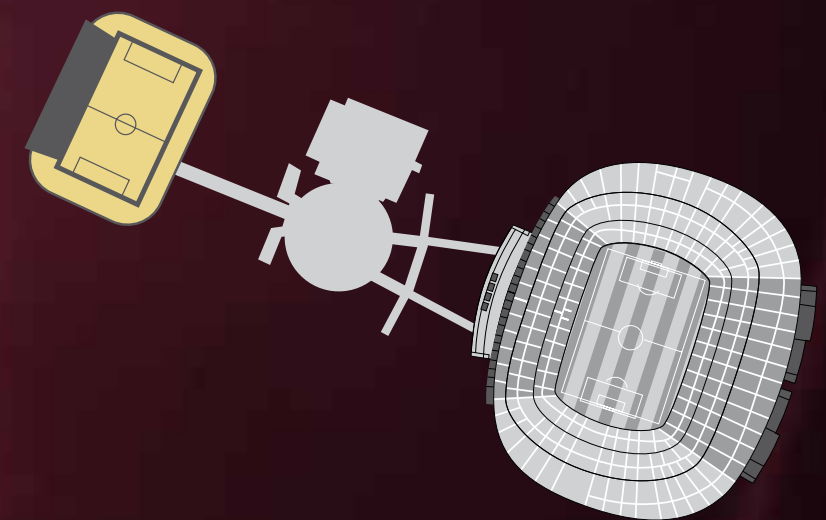



Sports complex Joan Gamper



Inaugurated in 2006 and just 10 minutes from the Camp Nou, its modern facilities are used for training by all the club's football teams, as well as the other sports teams.

It has 5 natural grass pitches, 4 artificial turf pitches, a multi-sports pavilion, gymnasium, service area and press room.

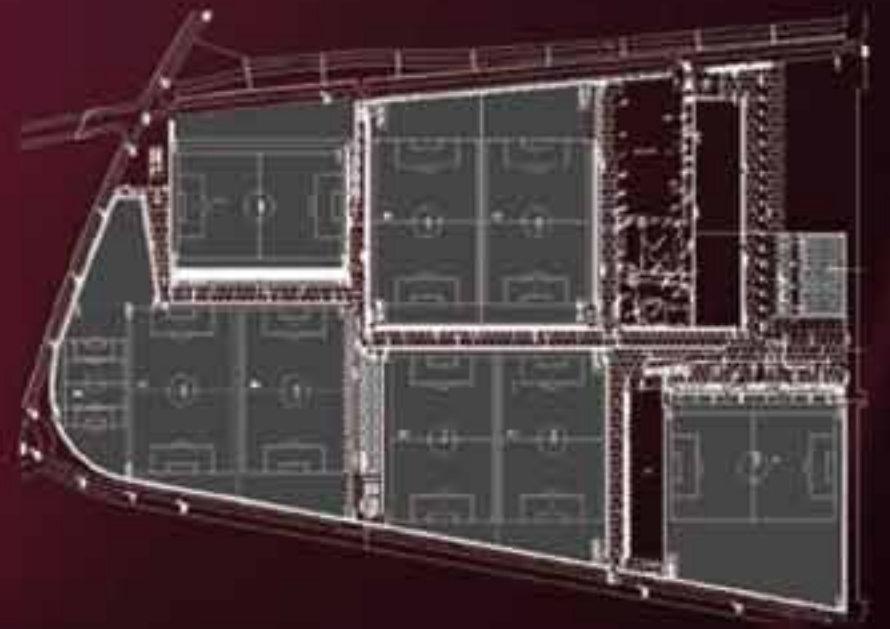



Palau Blaugrana Arena

The legendary Palau is used for games played by FC Barcelona's professional sports sections: basketball, handball, roller hockey and futsal. Its capacity for 7,500 spectators. It's famed for its large and unmistakable domed roof. Its facilities include a VIP lounge with the capacity for 100 people. It is ideal for, among other activities, large meetings, recordings and group activities.

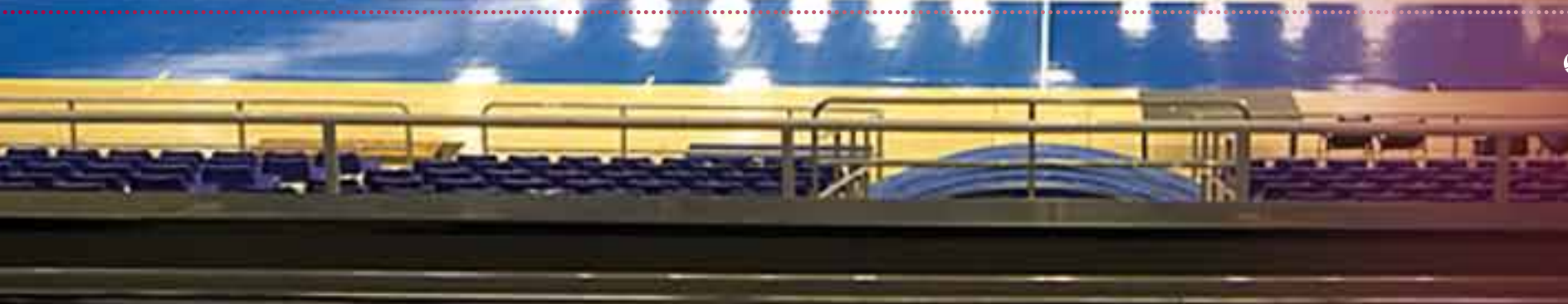
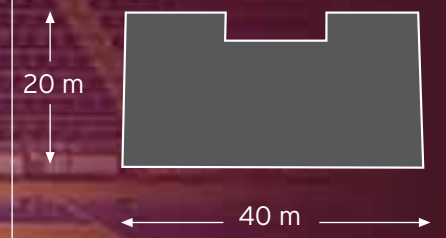

Ice Rink

One of the city's landmark sites. It has been used for leisure and competitive skating by thousands of Barcelonans ever since it was opened in the early 1970s. It is also used nowadays for group activities, recordings and corporate events.





The club works with the city's most prestigious catering companies, which are able to maintain the high standards of product and services required by our clients. Their flexibility, versatility and knowledge of the facilities means they can serve anything from small private meals to major events, always offering the best choices in terms of cuisine and services, such as:

- Coffee breaks
- Welcome drinks & snacks
- Cocktail lunches or suppers
- Work lunches
- Gala suppers
- Themed gastronomy



Exclusive services: Weddings at the Camp Nou



The Camp Nou has rooms and spaces with the capacity for between 100 and 800 people that can be the venue for wedding banquets and also, if you like, a civil ceremony beforehand.

This is a very different way of surprising your guests, by using such spaces as Sala Paris, Sala Roma, the Camp Nou Terrace (summer) or the Grandstand Hall. So, there is a choice of many options for hosting a special day with friends and family. Also included are such services as parking, access to photo session for bride and groom in some of the most exclusive parts of the Camp Nou and the possibility of using the stadium scoreboard to send a message of congratulations. The programme can also include such services as the Museum and Stadium Tour for all guests, the presence of trophies at the banquet, transport in the first team bus, and many more.



NIKEFOOTBALL.COM

BARÇA TV

Exclusive services: Barça You Play

Barça You Play lets you play a game at the Club's installations and make real the dream of so many fans to become, for a while at least, a real footballer. It's the perfect activity for companies and organisations who wish to offer a unique experience to their clients, associates or employees. It's an original public relations tool, an incentive, a part of a convention or business meeting and you don't need any special fitness level or footballing skills to take part. Barça You Play provides a complete personalised kit for each player, a referee, coaches from the FCB Escola, medical assistance, a photo reportage, Tour of the Camp Nou Experience for players and spectators alike, an FC Barcelona diploma of participation and a post match dinner in the Presidential Area of the Camp Nou.

Complementary services: Camp Nou Tour and Museum

The museum's prestige is such that it has become the most visited sports museum in the world. It's also the most visited museum of any type in Catalonia and one of the finest instruments for promoting the club's social and cultural projection.

During a visit to the museum, visitors get an idea of the size and origins of the club, as well as the charisma of the greatest stars that have worn the team colours over the years.

As well as the actual visit, the museum can offer other complementary options:

- **Camp Nou Tour:** This is the best way to experience Barça from the inside; the most emblematic corners of the Camp Nou can be viewed first hand, as visitors explore surprising and magical locations.
- **Exclusive night time opening:** the possibility of visiting the museum at night is an exclusive way to surprise your guests and enjoy a unique and different experience before or after holding an event.

Specific complementary services

1st Team Coach: the club's brand new coach, used by the players for away transport, can be used at your event subject to availability.

Photograph on the pitch: immortalise your event with a photograph on the Camp Nou turf, thus enjoying a different perspective of the venue and enjoying the sensation of walking out onto the field.

Video scoreboard and stadium megaphones: 2 LED screens of more than 70m² and offering 200,000W of sound, and which can be used as a support to complement any kind of event.

FC Botiga Megastore/ Merchandising: The stadium also houses the biggest of the many official FC Barcelona stores. Here you will find the ideal gifts and souvenirs of your visit.

Veteran matches: FC Barcelona offers the unique possibility of playing a game against your childhood heroes. Play a match against a team made up of former club players on the same facilities used for training by the current Barça stars.

Ex-players talks: Personalised talk by ex-Barça players with a recognised track record bringing together the values of sport and business. The presence of the players also provides a great opportunity to interact with these important figures in the Club's history.

In short, we can adapt to any request or need you might have with respect to making your event even more special.



General complementary services

Contact details



To add even more quality to your event and make life easier for you, FC Barcelona can also provide the following additional services:

Photograph and video: Professionals with ample experience of immortalising events in the best possible way.

Sound and lighting: The resources you need to create the right ambience for your event.

Signs and corporate image: Maximum flexibility in personalising the rooms with your corporate image.

Audiovisual equipment: We provide video and sound projection equipment for use in your events and presentations.

Stewardesses: The main agencies in Barcelona are regular collaborators with the club, and have perfect knowledge of the protocols and facilities.

For more information, detailed budgets, availability and reservations:

E-mail: events@fcbarcelona.cat

Telephones: +34 93 496 37 94
+34 93 496 36 35
+34 93 496 36 00

Web: www.fcbarcelona.cat



FCB Hospitality services



Camp Nou Hospitality (VIP seats & private boxes)

Imagine living this experience from a privileged vantage point, with an unbeatable view of the pitch and enjoying special comforts in an exclusive setting. VIP Tickets Camp Nou is one of the products forming part of the FC Barcelona VIP Zone Programme, and provides you with:

Matchday

This option allows you to purchase VIP tickets for specific matches. A wide range of exclusive seats are available to satisfy all your company's hospitality and public relations needs. We offer a catering, stewardess, exclusive VIP lounge access, TV circuit and match line-up service for all games.

Season

With this option you can enjoy your VIP seats or private box for every game in a given season. You will also form part of FC Barcelona's corporate association Club Empresa. We exclusively offer all kinds of comforts, including the opportunity for your company to select the level of privacy, services and comfort that are required to meet your particular needs.

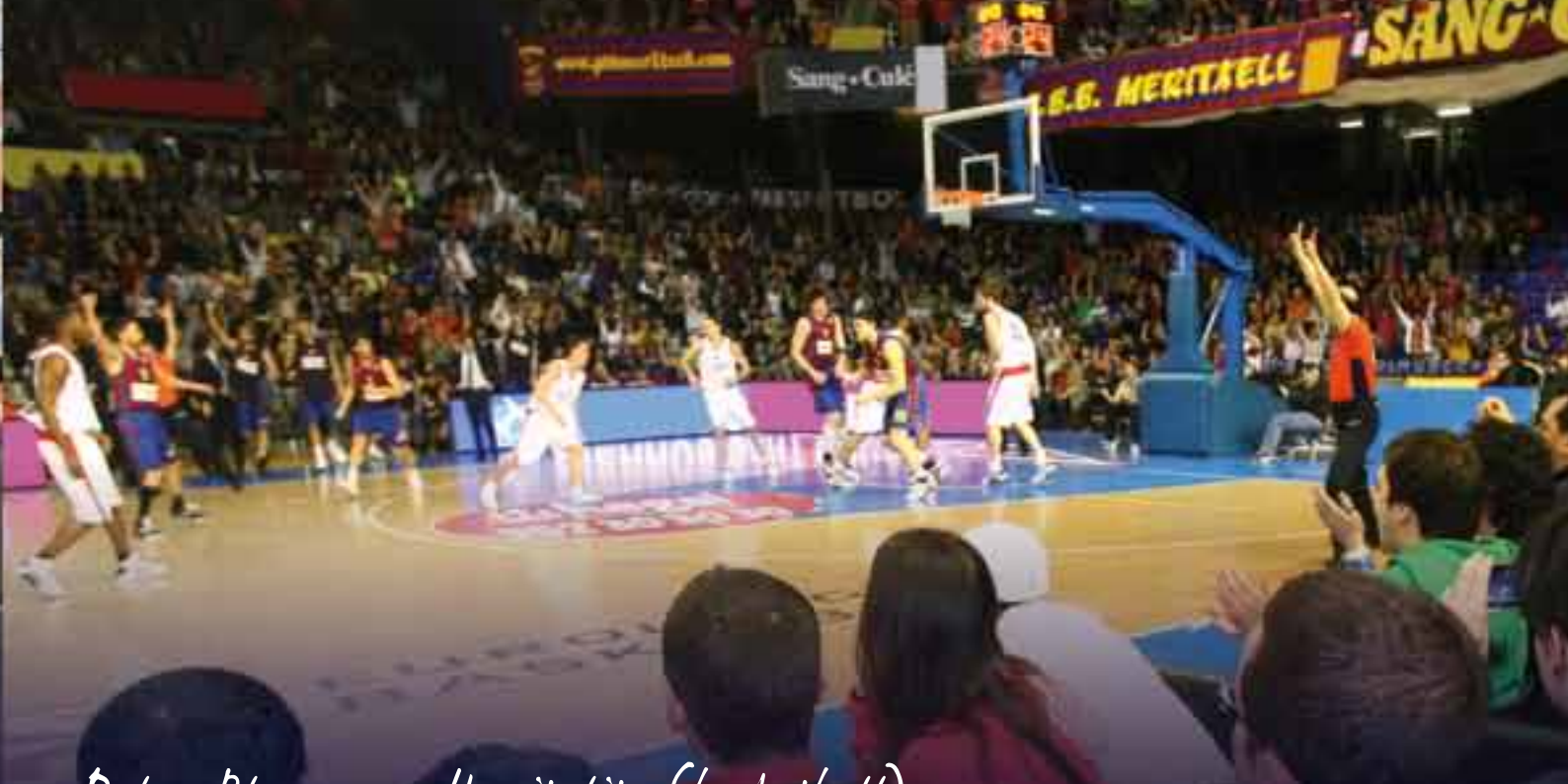

Palau Blaugrana Hospitality (basketball)

Enjoy FC Barcelona Regal and some of the best basketball in Europe in a wonderful venue. There is no better place to appreciate the essence of what basketball is about. Sit back in the most exclusive seats in the Palau Blaugrana and enjoy all the comforts of being able to access the VIP lounge.

Palau Box

Seats right next to the Presidential Box that offer an unbeatable tactical view of the court, all in exclusive surroundings shared with important personages and former players.

Courtside Box

Boxes right down at the courtside. These seats are so close to the action you almost feel part of the team. There is no better way to enjoy the game from a first person perceptive.

You can enjoy all games in the Euroleague (Regular Season, Top 16 and Play-off), and all ACB games too (regular season and play-offs). Minimum of 25 matches guaranteed.



The FC Barcelona facilities are situated right in the urban heart of the city, just 10 minutes from the city centre and 15 minutes from the airport.

They can easily be accessed by any form of transport, be that public and private transport or by taxi, and there are parking facilities on the club grounds.

